

დარიჟანგა

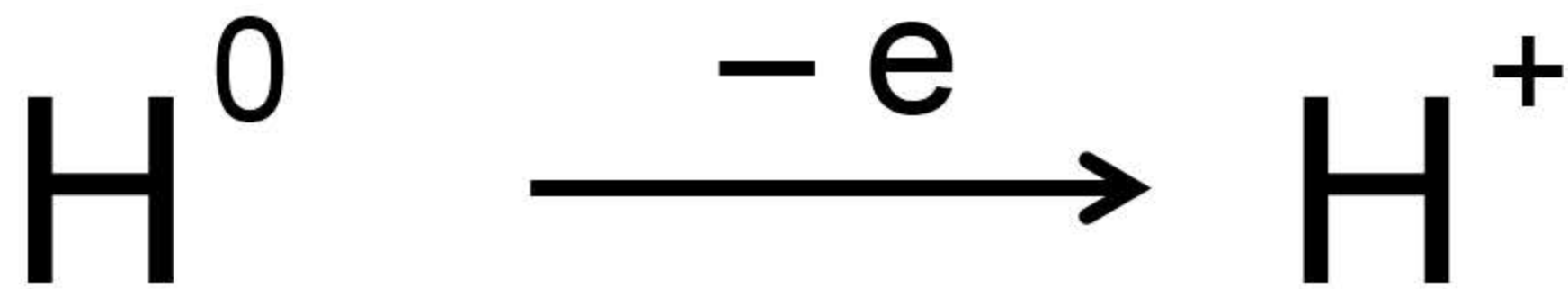

დანიშნულება

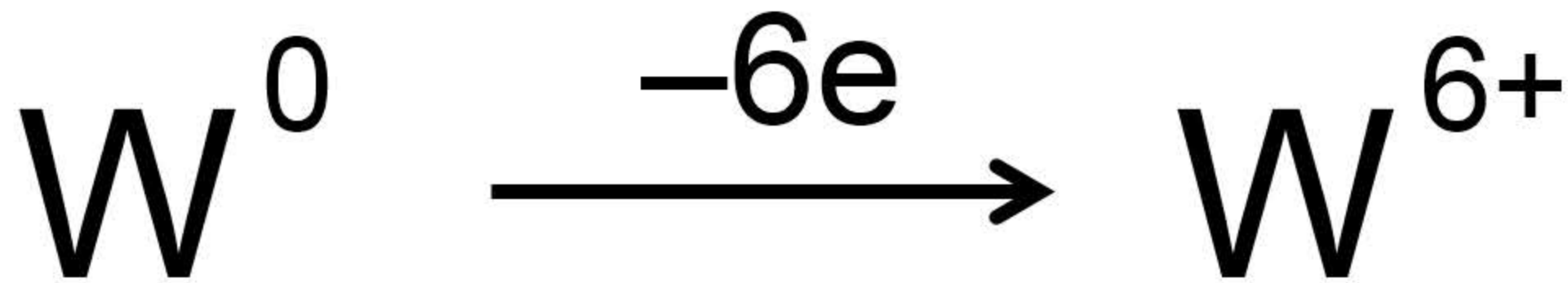



დანიშნულება

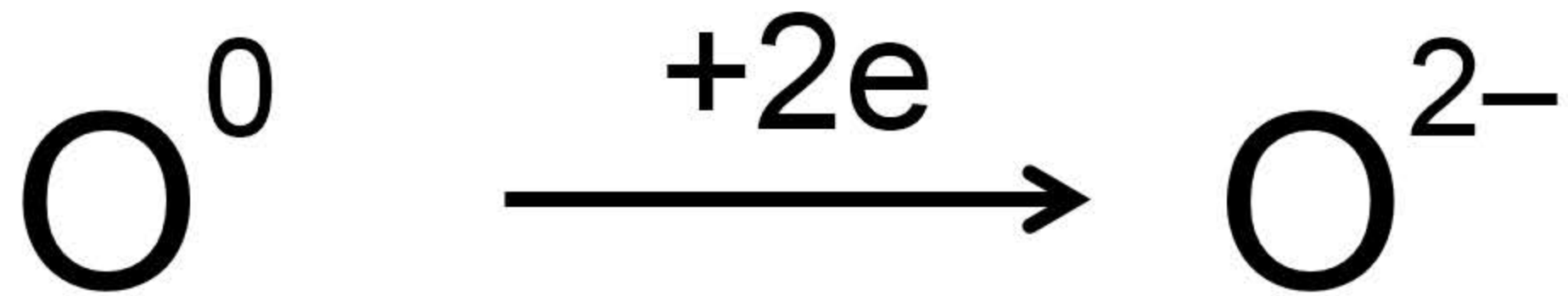
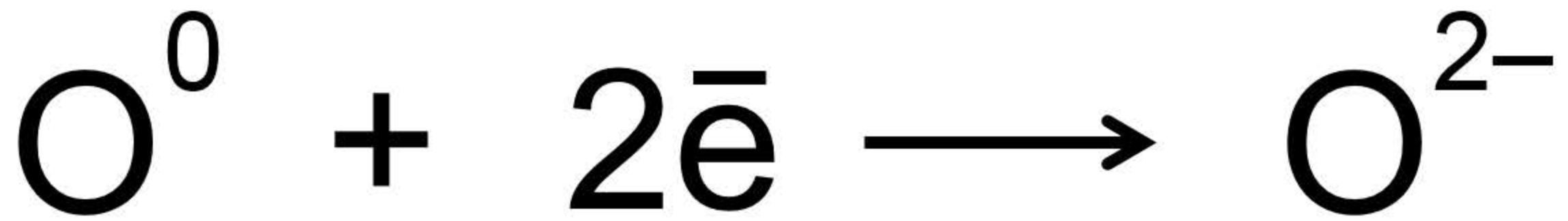

აღდგა

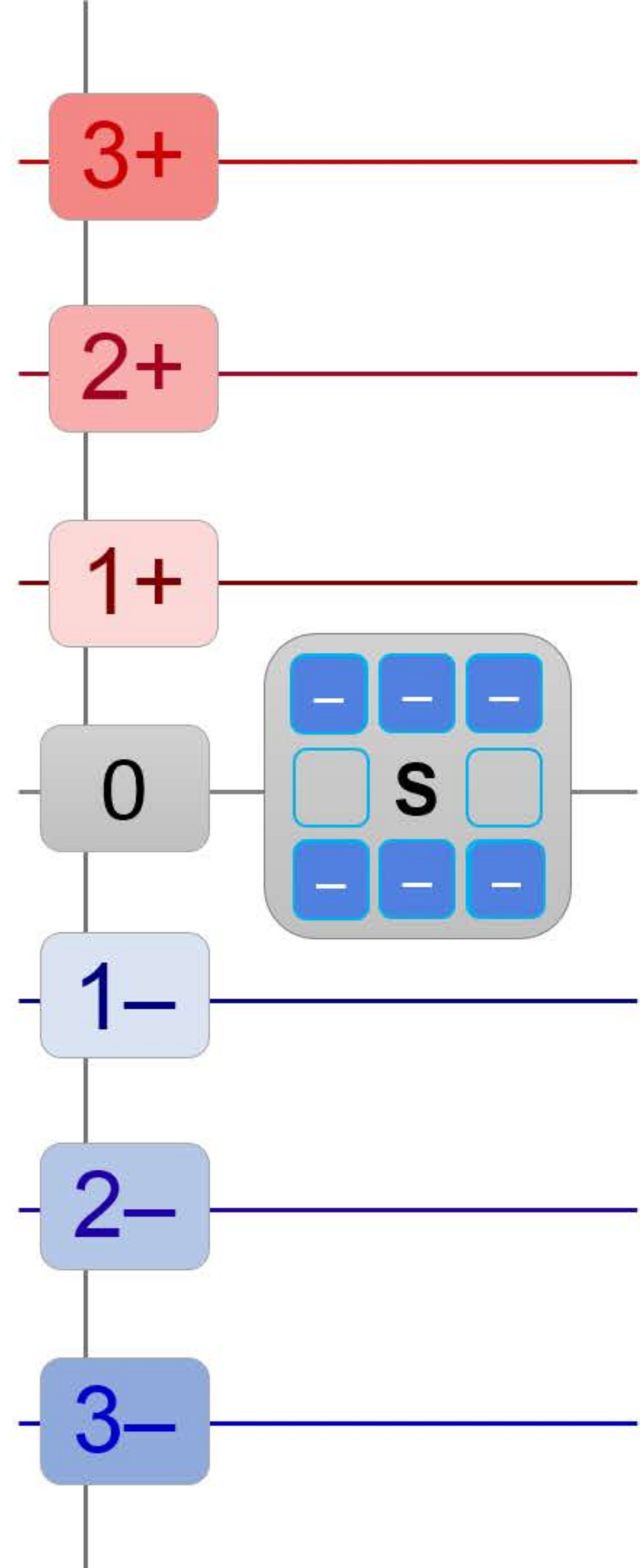
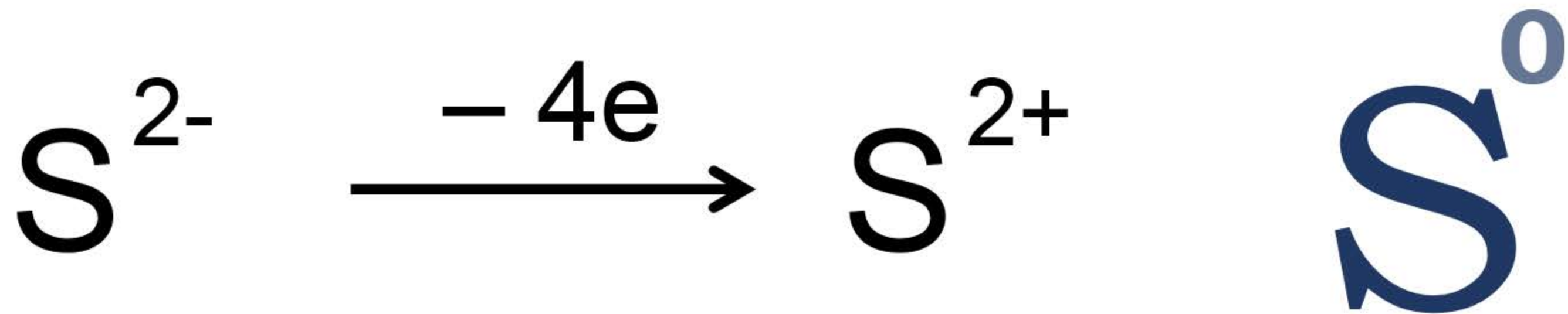

$\mathbb{S}_-$

3+

2+

1+

0

1-

2-

3-



$\mathbb{S}^{2-}$

3+

2+

1+

0

1-

2-

3-

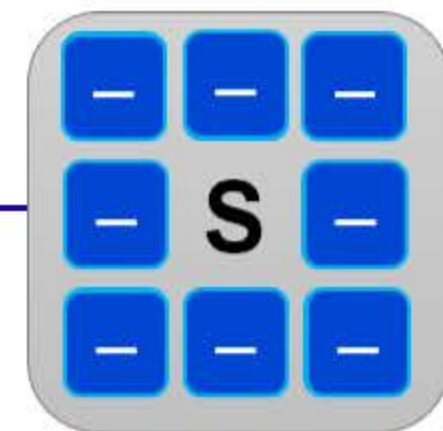

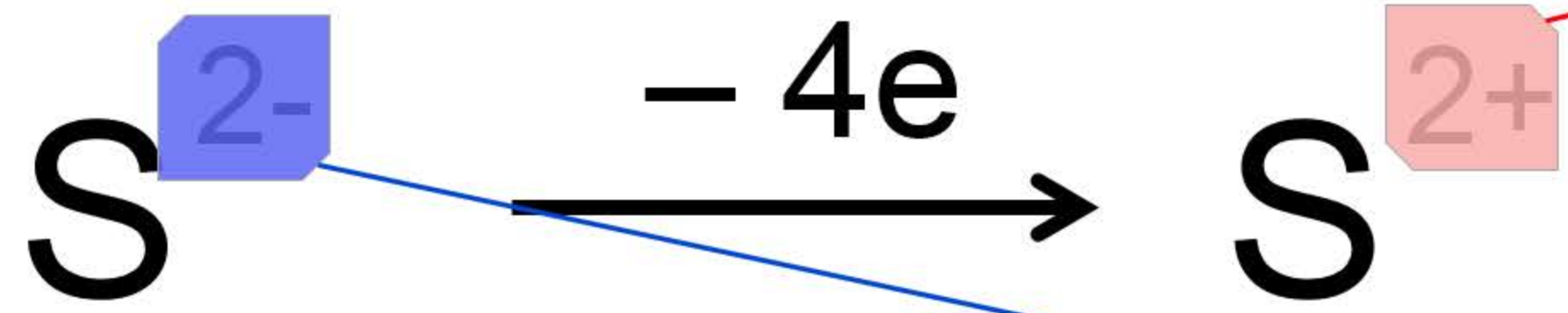

$S^{2-}$

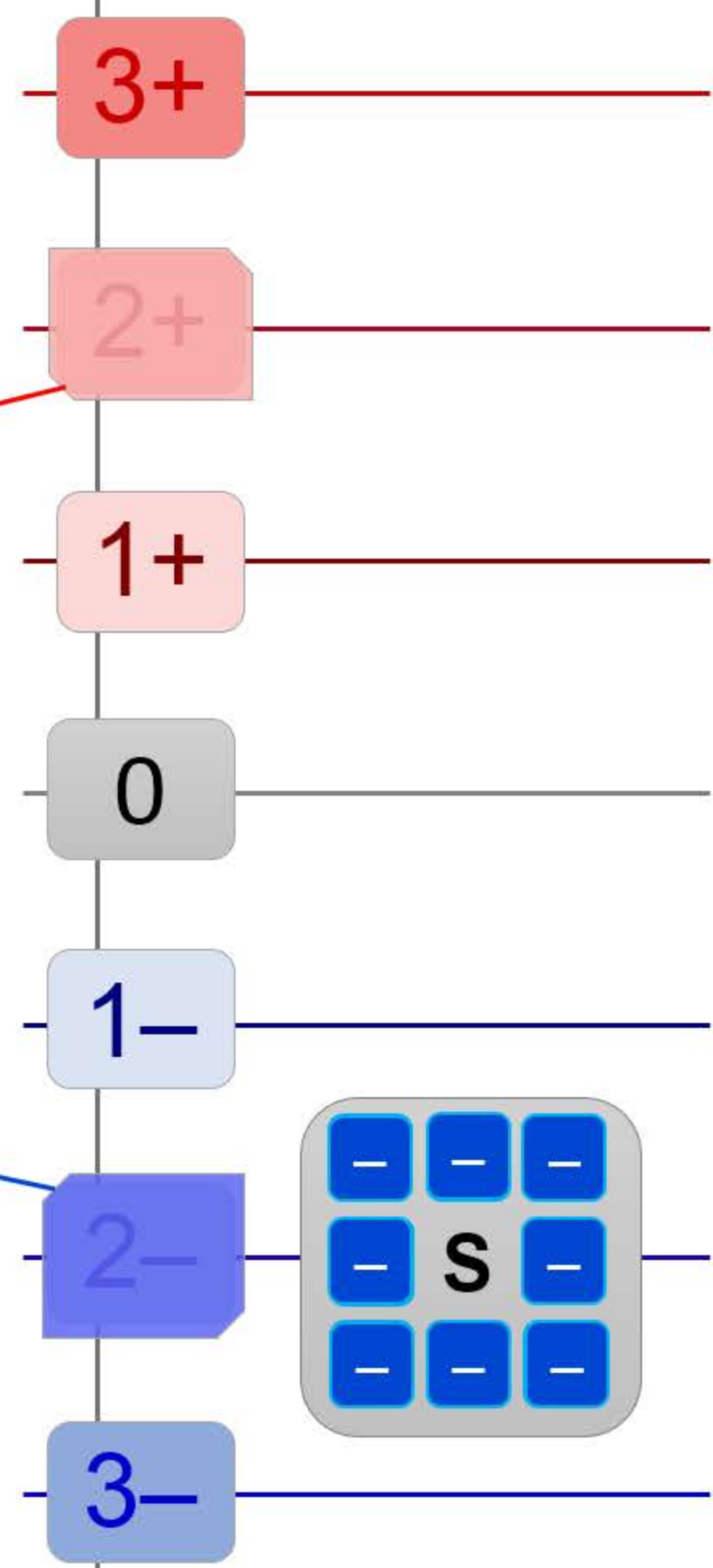

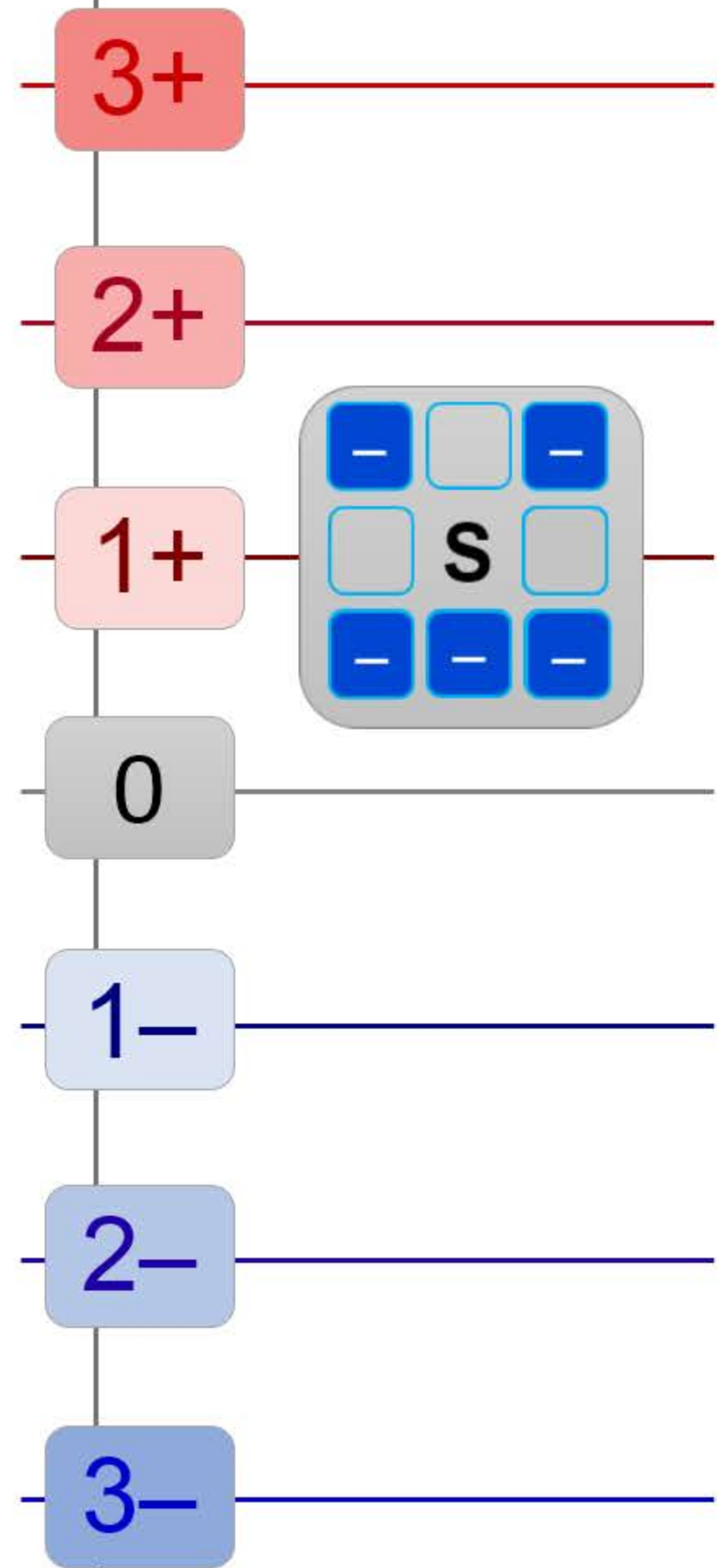
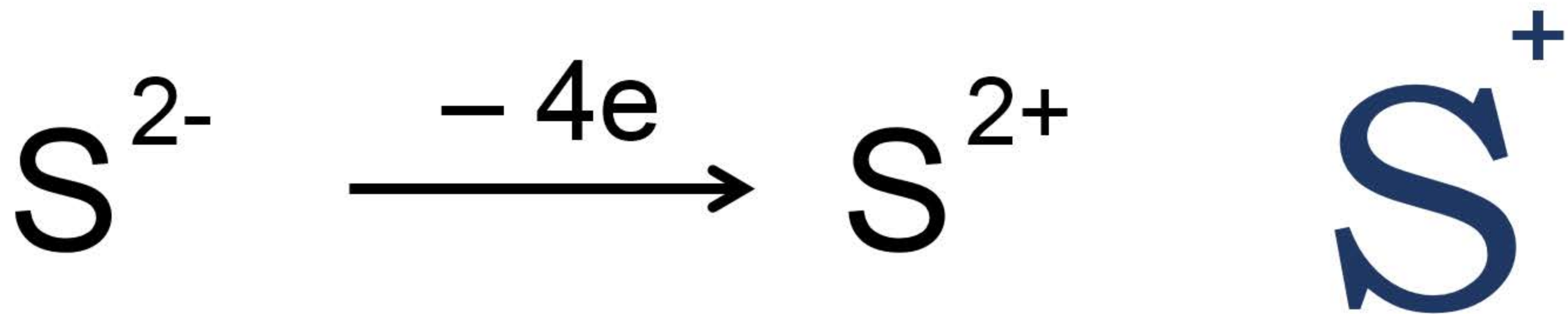



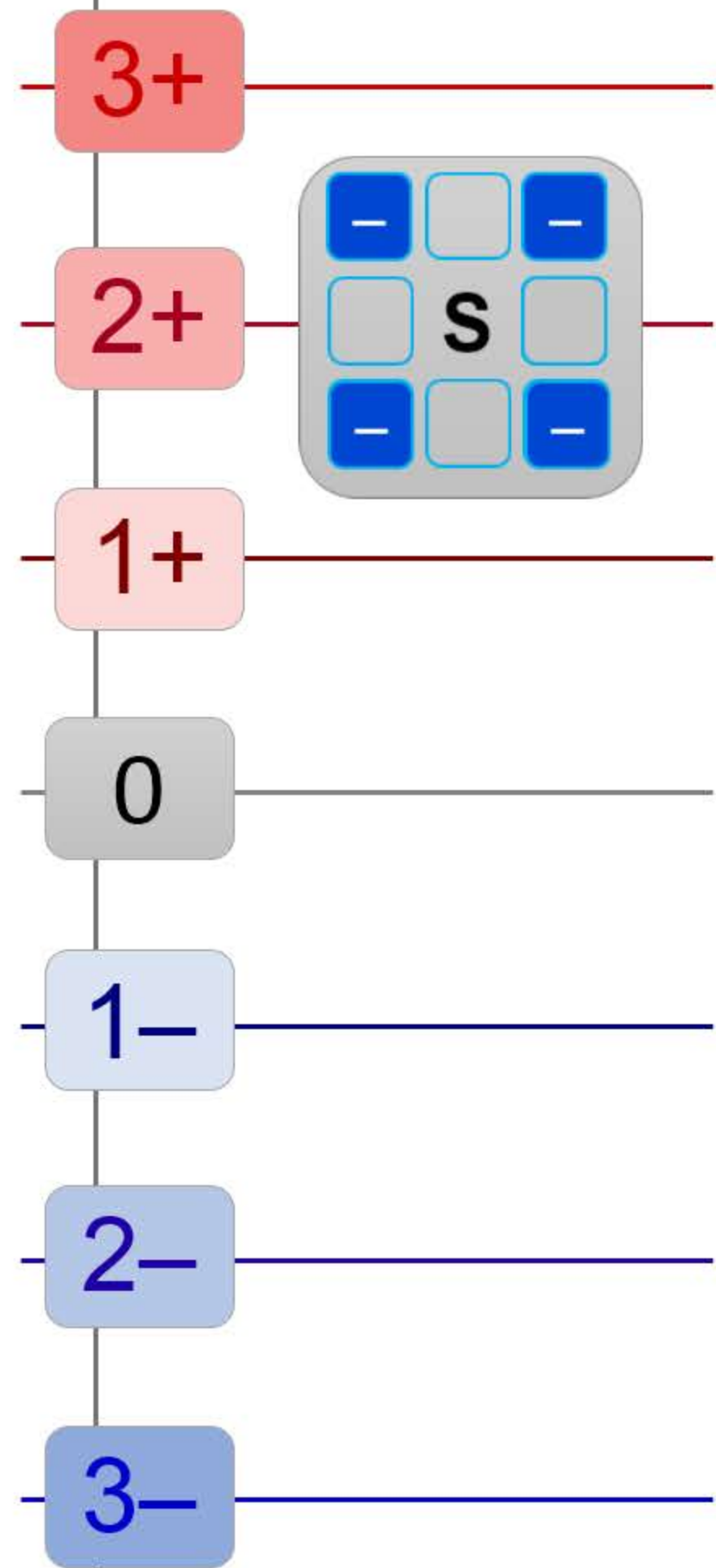
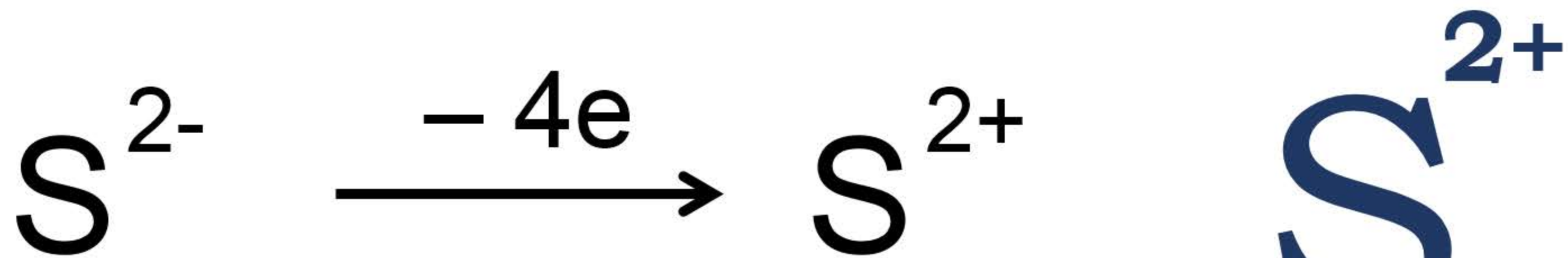



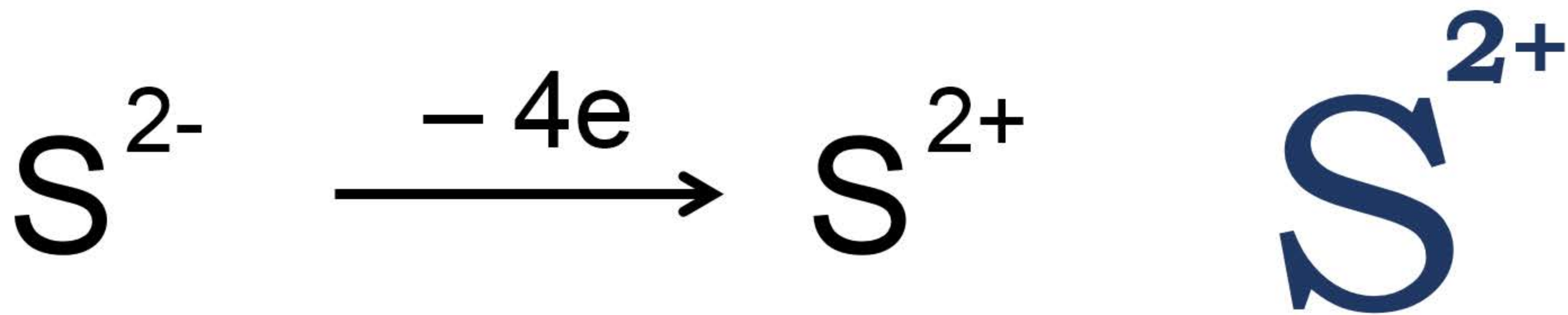

დაიჟანგა

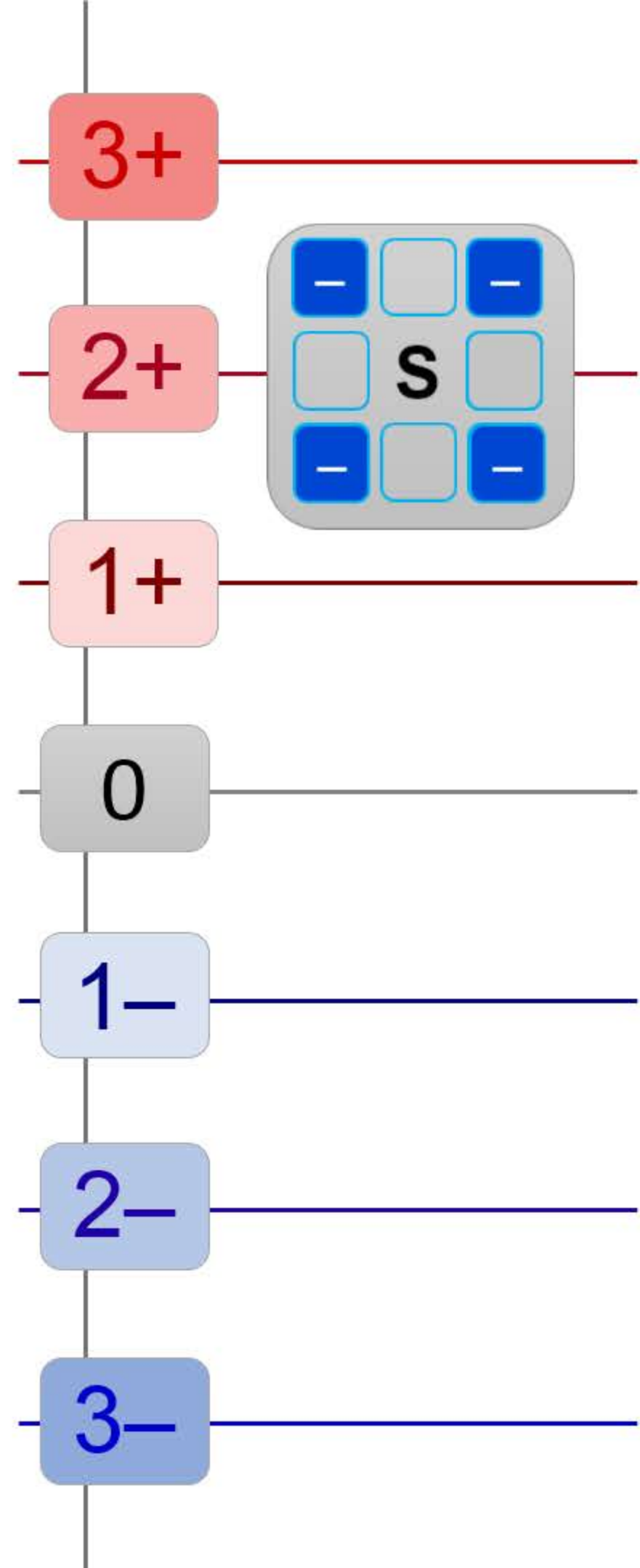

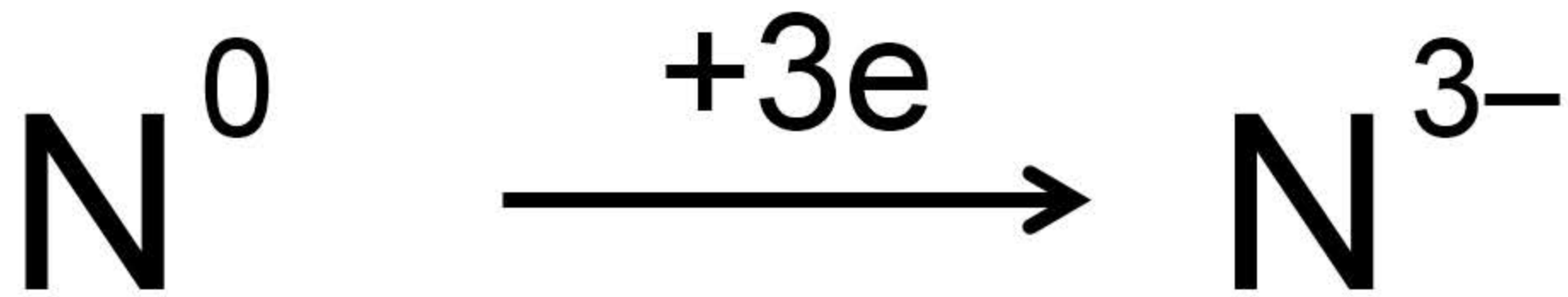

აღდგა

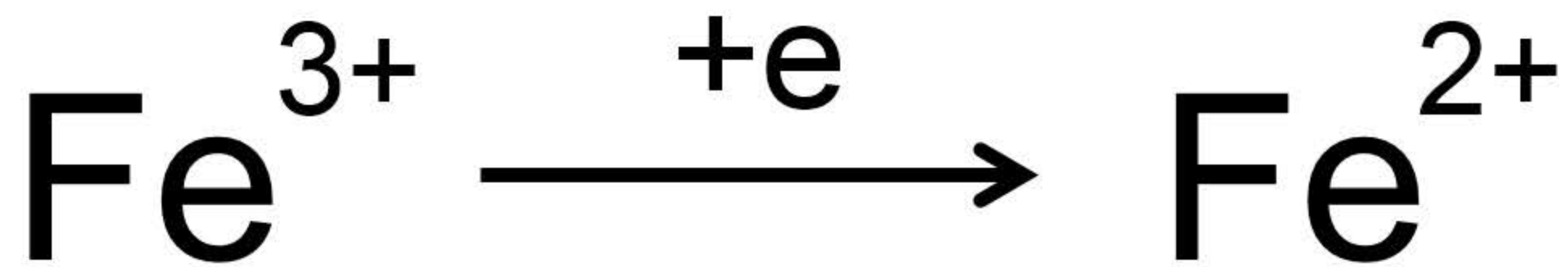
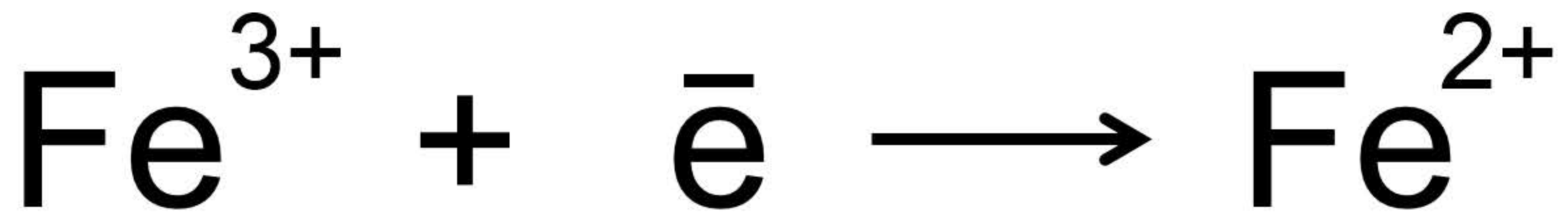

აღდგა

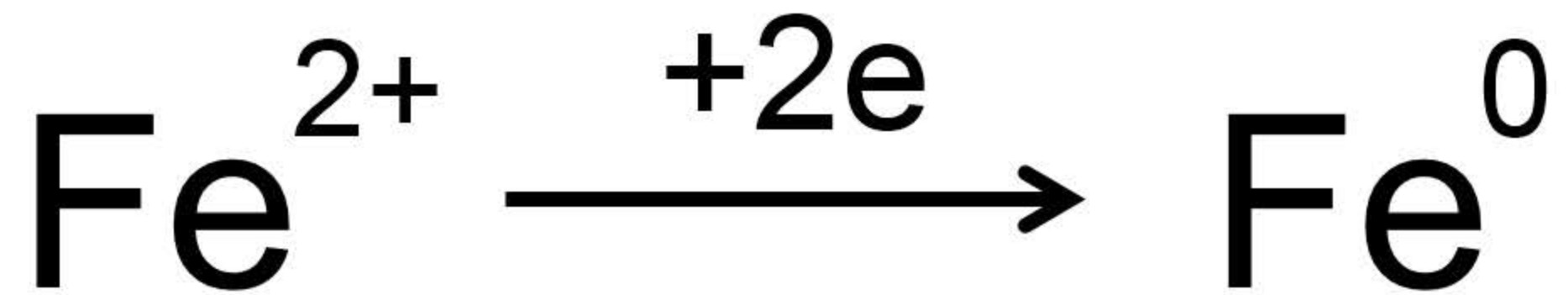

აღდგა